



World-Class Instrumentation for the Global Vehicle Marketplace

C-COM 12GX-100

CAN-Communicator 12-Inch Display

FEATURES

- 12.1-inch TFT LCD display
- In-Plane Switching (IPS) for wide viewing angle
- Resolution: 1280 x 800
- Capacitive touchscreen, optically bonded
- Portrait or landscape mode
- Sealed to IP6K5 specifications front and rear
- Ambient light sensor
- MicroSD card
- 2 CAN J1939 ports
- 2 switched ethernet ports
- 2 analog camera Inputs
- Internal buzzer
- +9 to +36 VDC operating voltage
- 4 configurable switch to ground inputs/outputs
- 4 switch to battery inputs
- 1 frequency input
- Optional real time clock with 10+ day backup

APPLICATIONS

- Construction equipment, cranes, road-building
- Farm and agricultural vehicles
- Earth-moving, and mining vehicles
- Buses, coaches and recreational vehicles
- Heavy trucks
- Military vehicles
- Forklifts, wheel loaders and skid steers
- Utility and emergency vehicles



AMETEK VIS' C-COM 12GX-100 display is part of the CAN Communicator family of graphics display products that can satisfy the instrumentation requirements for all vehicle platforms.

This display is designed to be the primary or secondary HMI interface for the vehicle and includes the ability to display multiple camera views from analog or ethernet inputs. Video can be recorded from a camera stream and stored on an easily accessible MicroSD card.

The optically bonded, high resolution touchscreen display enhances readability and the anti-glare surface reduces sunlight reflection for an easy to read interface with any vehicle or system. In-plane switching allows for a wide viewing angle in either portrait or landscape mode.

C-COM 12GX features an ambient light sensor to automatically adjust the backlight intensity or backlight mode for day and night time operation.

Software development is supported either through our Linux based board support package (with VAPS XT as the recommended tool) or as a collaborative effort with our engineering team.

C-COM 12GX is sealed to IP6K5 specifications both front and rear. Designed to withstand harsh conditions typical of off-road environments, the display meets SAE and ISO requirements for vehicular instrumentation.



VEHICULAR INSTRUMENTATION SYSTEMS

287 27 Road, Grand Junction, CO 81503 U.S.A. • Phone: +1 970-242-8863 • Fax: +1 970-245-6267
 Web: www.ametekvis.com • E-mail: info.vis@ametek.com

World-Class Instrumentation for the Global Vehicle Marketplace

SPECIFICATIONS

Physical Characteristics

12.1-inch TFT LCD display, IPS
Capacitive touchscreen: Glove capable and water tolerant
1280 x 800, 1020 cd/m²
Mating connector: 34 pin ATAC
Sealed to IP6K5, front and rear
Mounting: VESA, 75mm x 75mm

Electrical Inputs/Outputs

4 configurable switch to ground inputs/outputs
4 switch to battery inputs
1 frequency input

Electrical Characteristics

Operating limits: 9 to 36 VDC, reverse polarity protected

Standards

ISO 16750	UNECE R118
ISO 20653	UNECE R10
ISO 10605	MIL-STD-810F
ISO 7637	MIL-STD-202H
ISO 11452	MIL-STD-461G
IEC 68-2-27	MIL-STD-462D
IEC CISPR 25	SAE J1113
EN 55022	SAE J1455
EN 61000-4-2	

Environmental Characteristics

Temperature, humidity, shock, vibration, and salt spray:
meets or exceeds SAE # J1455-2012-08 and ISO 16750
Operational temperature: -30C to +85C
Storage temperature: -40C to +85C

Video

NTSC/PAL/SECAM auto detection
2 CVBS analog camera inputs
2 ethernet camera inputs (M12 X4 D-Coded)
Video recording capability via MicroSD card

Communication

2 CAN 2.0 part B and ISO 11898 compliant

DIMENSIONS

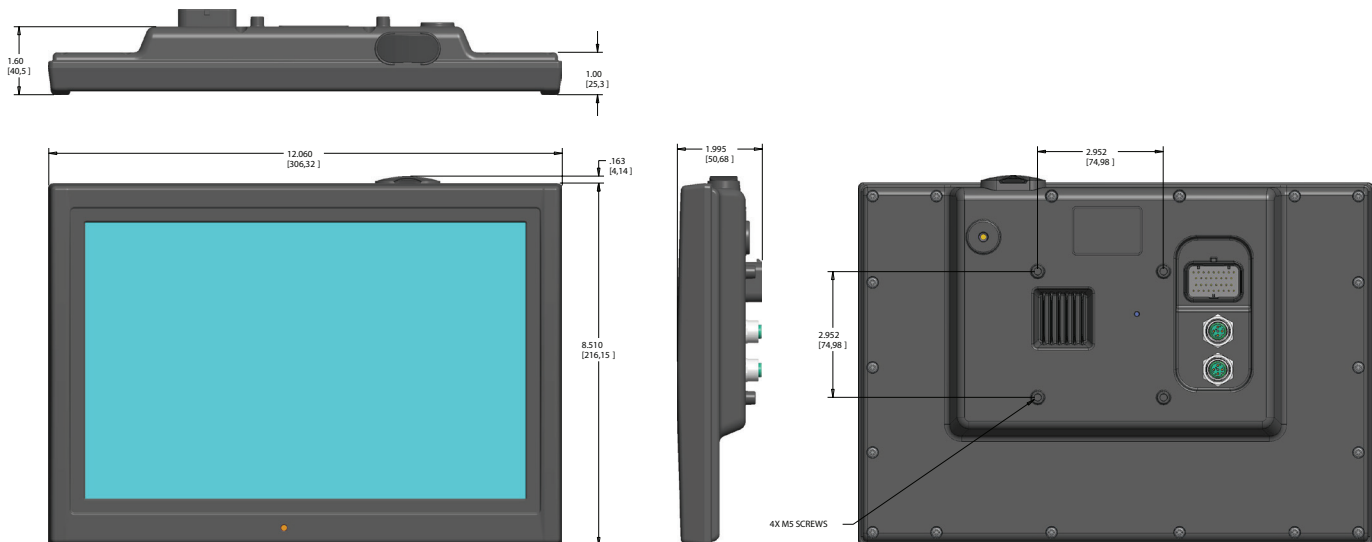

VEHICULAR INSTRUMENTATION SYSTEMS

287 27 Road, Grand Junction, CO 81503 U.S.A. • Phone: +1 970-242-8863 • Fax: +1 970-245-6267
Web: www.ametekvis.com • E-mail: info.vis@ametek.com